

Qlamp LED Floodlight 200W with 4 chips

Q-FL-200W-CL7



DESCRIPTION:

- High brightness COB Led Chip as light source low voltage constant current drive.
- Made by high pure Aluminum alloy, static electricity spraying finish on the surface.
- Good heat dissipation, high adhesive force, waterproof, dustproof and fresh structure.
- Using screw installation, installation process is quick and easy, fixed solid.
- Widely used for outdoor night piece lighting project, applied for factory, mine field, warehouse etc.

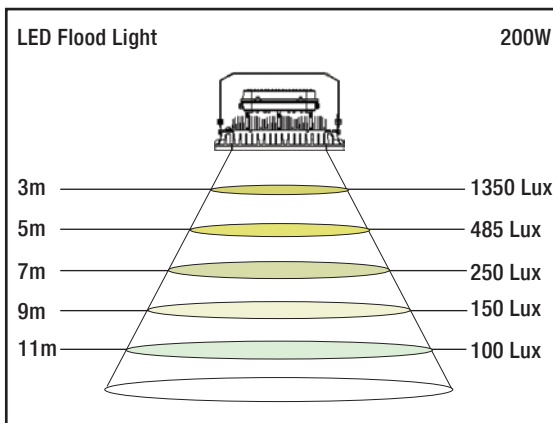
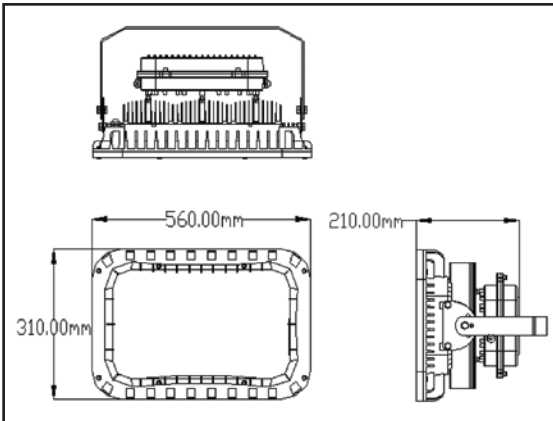

TECHNICAL SPECIFICATION	
Model No.	Q-FL-200W-CL7
LED Type	COB
Power	4*50W
Dimension	560X310X210mm
Input voltage (V)	85~265V AC
Lumen	17000lm
CCT	2800~7000K
Beam Angle	120°
Color index	≥75
Efficiency	≥85%
Frequency	47~ 63Hz
Decay	<3% within 3000Hrs
Life Span	≥50,000H
Material	Aluminum
IP rating	IP65
Humidity	5~95% R.H.
Working temperature	-20°C~55°C
Storage temperature	-40°C~85°C
Warranty 2 years	Epistar chip+Normal drive
Warranty 3 years	Epistar chip/bridgelux chip +Meanwell drive

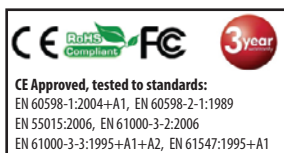

POWERSAVE SOLUTIONS LTD

HEAD OFFICE: Unit 7, The Sandon Estate, Sandon Way, Liverpool L5, 9YN

LONDON OFFICE: 152-154 Coles Green Road, NW2 7HD

e-mail: info@powersavesolutions.co.uk [facebook.com/powersavesolutions](https://www.facebook.com/powersavesolutions) www.powersavesolutions.co.uk